



eSPARK™



⚠ NOTE: The eSpark must be traveling up to 3mph before motor will engage. Kick start up to 3mph while twisting the throttle to engage motor.

OWNER'S MANUAL

**Read and understand this entire manual before riding!
DO NOT RETURN TO STORE!**

NOTE: Manual illustrations are for demonstration purposes only. Illustrations may not reflect exact appearance of actual product. Specifications subject to change without notice.

CONTENTS

Safety Warnings	1-2	Repair and Maintenance.....	6-8
Before You Begin.....	3	Troubleshooting Guide.....	9-10
Assembly and Set-Up.....	3-5	Electric Scooter Parts	11
Connectors/Hardware Maintenance.....	5	Warranty	13

SAFETY WARNINGS

WARNING: SPARKS CAN INDUCE FIRE

To reduce the risk of **SERIOUS INJURY** or **FIRE**:

PARENTS and RIDERS: Make sure riders understand that sparks can start a fire. Keep sparks away from flammable or combustible substances. Use only under close adult supervision.

BE RESPONSIBLE: Safety is important. Parents must review the following warnings and instructions with each rider:

- For outdoor use only on solid, clean, dry, hardened surfaces. Keep sparks away from substances that can catch fire, such as dry vegetation, paper, chemicals or gasoline. Sparks can induce fire.
- Do not use in any area prone to wildfires or posted by fire authorities as a Fire Hazard Zone.
- Never use your scooter to try to start a fire. Your eSpark™ scooter emits localized sparks when the Spark Bar on a moving scooter comes in contact with hardened outdoor surfaces like asphalt or concrete. Be responsible.
- Do not ride at night.
- Keep sparks away from eyes, hair, exposed skin and clothing. Sparks can burn.
- Spark Bar and cartridge get hot during use. Do not touch after use.
- Do not depress the Spark Bar continuously - only for short periods - while the scooter is moving under power, as this may overheat components. Always allow to cool (at least 15 minutes recommended) before replacing a worn spark cartridge.
- Observe all other eSpark scooter safety warnings and instructions as provided elsewhere in this manual.

 **WARNING:** Riding the electric scooter can be a hazardous activity. Certain conditions may cause the equipment to fail without fault of the manufacturer. Like other electric products, the scooter can and is intended to move and it is therefore possible to lose control, fall off and/or get into dangerous situations that no amount of care, instruction or expertise can eliminate. If such things occur you can be seriously injured or die, even when using safety equipment and other precautions. **RIDE AT YOUR OWN RISK AND USE COMMON SENSE.**

This manual contains many warnings and cautions concerning the consequences of failing to maintain, inspect or properly use your electric scooter. Because any incident can result in serious injury or even death, we do not repeat the warning of possible serious injury or death each time such a possibility is mentioned.

APPROPRIATE RIDER USE AND PARENTAL SUPERVISION

This manual contains important safety information. It is your responsibility to review this information and make sure that all riders understand all warnings, cautions, instructions and safety topics and assure that young riders are able to safely and responsibly use this product. Razor recommends that you periodically review and reinforce the information in this manual with younger riders, and that you inspect and maintain your child's scooter to insure their safety.

The recommended rider age is 8 and older. Any rider unable to fit comfortably on the scooter should not attempt to ride it. A parent's decision to allow his or her child to ride this product should be based on the child's maturity, skill and ability to follow rules.

Keep this product away from small children and remember that it is intended for use only by persons who are, at a minimum, completely comfortable and competent while operating the scooter.

DO NOT EXCEED THE WEIGHT LIMIT OF 120 pounds (54kg). Rider weight does not necessarily mean a person's size is appropriate to fit or maintain control of the scooter.

Do not touch the brakes, Spark Bar or motor on your scooter when in use or immediately after riding as these parts can become very hot..

ACCEPTABLE RIDING PRACTICES AND CONDITIONS

Always check and obey any local laws or regulations which may affect the locations where the electric scooter may be used.

Ride defensively. Watch out for potential obstacles that could catch your wheel or force you to swerve suddenly or lose control. Be careful to avoid pedestrians, skaters, skateboards, scooters, bikes, children or animals who may enter your path, and respect the rights and property of others.

Do not activate the speed control on the hand grip unless you are on the scooter and in a safe, outdoor environment suitable for riding. **The electric scooter must be moving at 3 miles per hour before the motor will engage.**

Do not attempt or do stunts or tricks on your electric scooter. The scooter is not made to withstand abuse from misuse such as jumping, curb grinding or any other type of stunts.

Maintain a hold on the handlebars at all times.

Never allow more than one person at a time to ride the scooter.

Never use near steps or swimming pools.

Keep your fingers and other body parts away from the chain, steering system, wheels and all other moving components.

Never use headphones or a cell phone when riding.

Never hitch a ride with another vehicle.

Do not ride your scooter in wet or icy weather and never immerse the scooter in water, as the electrical and drive components could be damaged by water or create other possibly unsafe conditions.

The electric scooter is intended for use on flat, dry surfaces such as pavement or level ground without loose debris such as sand, leaves, rocks or gravel. Wet, slick, bumpy, uneven or rough surfaces may impair traction and contribute to possible accidents. Do not ride your scooter in mud, ice, puddles or water. Avoid excessive speeds that can be associated with downhill rides. Never risk damaging surfaces such as carpet or flooring by use of an electric scooter indoors.

Do not ride at night or when visibility is limited.

Observe all other eSpark safety warnings and instructions as provided elsewhere in this manual.

SAFETY WARNINGS

PROPER RIDING ATTIRE

Always wear proper protective equipment such as an approved safety helmet (with chin strap securely buckled), elbow pads and kneepads. A helmet may be legally required by local law or regulation in your area. A long-sleeved shirt, long pants, and gloves are recommended. Always wear athletic shoes (lace-up shoes with rubber soles), never ride barefooted or in sandals, and keep shoelaces tied and out of the way of the wheels, motor and drive system.

USING THE CHARGER

The charger supplied with the electric scooter should be regularly examined for damage to the cord, plug, enclosure and other parts, and in the event of such damage, the scooter must not be charged until the charger has been repaired or replaced.

Use only with the recommended charger.

Use caution when charging.

The charger is not a toy. Charger should be operated by an adult.

Do not operate charger near flammable materials.

Unplug charger and disconnect from scooter when not in use.

Always disconnect from the charger prior to wiping down and cleaning your scooter with liquid.

! WARNING: ALWAYS INSPECT SCOOTER PRIOR TO RIDING. Properly inspecting and maintaining your scooter can reduce the risk of injury. Always inspect your scooter before riding and regularly maintain it.

! WARNING: CHECK LOCAL LAWS REGARDING SCOOTER USE. Check local laws and regulations to see where and how you may use your Razor scooter legally. In many states and local areas scooter riders are required BY LAW to wear a helmet. Check local laws and regulations regarding laws governing helmet use and scooter operation in your area, including laws or regulations designating High Fire Hazard areas.

FAILURE TO USE COMMON SENSE AND HEED THE ABOVE WARNINGS FURTHER INCREASES SUCH RISKS OF SERIOUS INJURY. USE AT YOUR OWN RISK AND WITH APPROPRIATE AND SERIOUS ATTENTION TO SAFE OPERATION. USE CAUTION.

BEFORE YOU BEGIN

Remove contents from box. Remove the foam separators that protect the components from damage during shipping. Inspect the contents of the box for scratches in the paint, dents or kinked cables that may have occurred during shipping. Because the scooter was 95 percent assembled and packed at the factory, there should not be any problems, even if the box has a few scars or dents.

MAKE SURE POWER SWITCH IS TURNED "OFF" BEFORE CONDUCTING ANY MAINTENANCE PROCEDURES.

Estimated Assembly and Set-Up Time

Razor recommends assembly by an adult with experience in bicycle mechanics. Allow up to 20 minutes for assembly, not including initial charge time. Allow up to 12 hours for initial charge (see page 4 for charging information)

Charger

(Note: Charger design may vary from one shown)

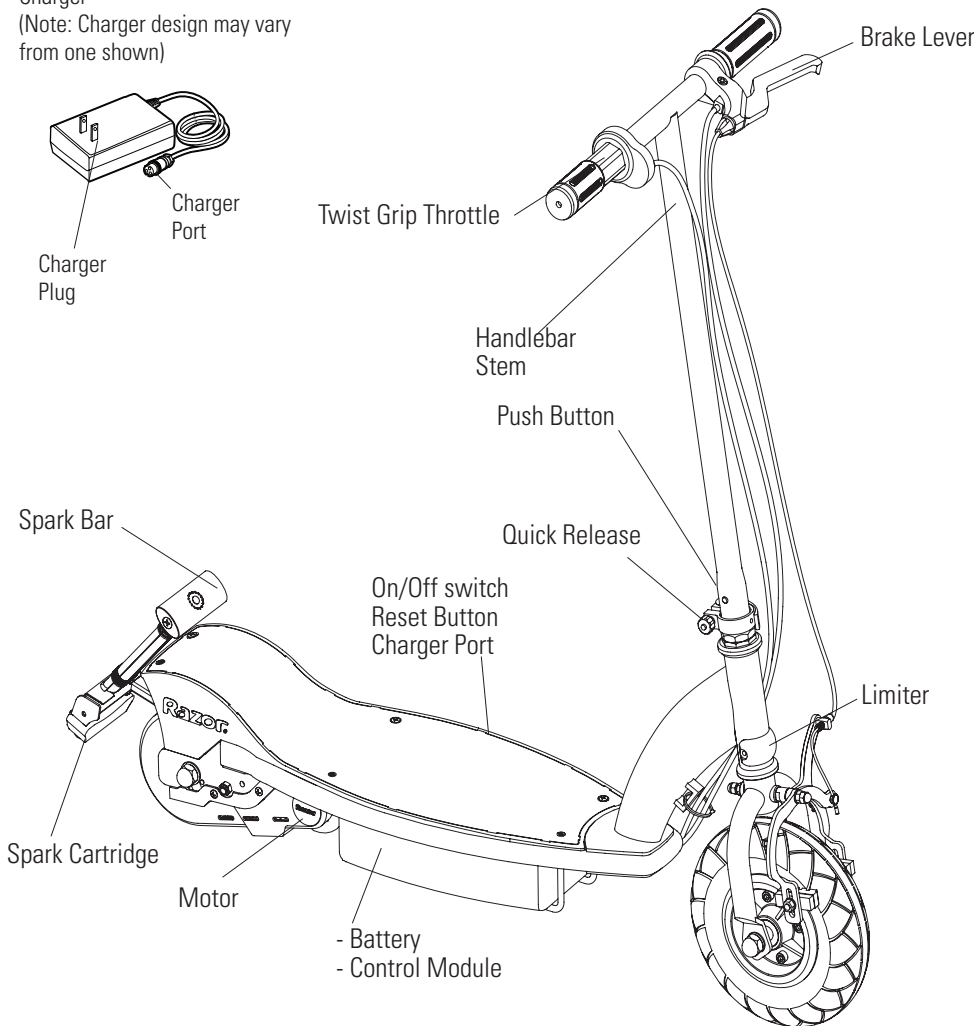

WARNING: DO NOT USE NON-RAZOR PRODUCTS WITH YOUR RAZOR ELECTRIC SCOOTER. The scooter has been built to certain Razor design specifications. The original equipment supplied at the time of sale was selected on the basis of its compatibility with the frame, fork and all other parts. Certain aftermarket products may not be compatible and will void the warranty.

Note: Electric scooter must be moving at 3mph/5km while twisting the throttle to engage motor.

Required Tools

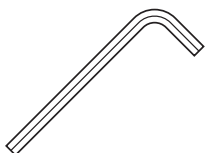

5mm Allen wrench (Included)



8mm, 10mm, 13mm and 16mm open wrenches (Not Included)

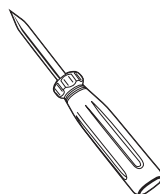

Phillips Screwdriver (Not Included)

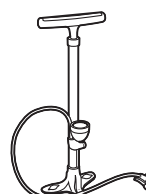

Bicycle-style tire pump for Schrader valve tires, with pressure gauge (Not included)

Need Help? Visit our web site for replacement parts, product support and a list of authorized service centers at www.razor.com or call toll free 866-467-2967 Monday - Friday 8AM - 5PM Pacific Time.

ASSEMBLY AND SET-UP

□ Attaching the Handlebars

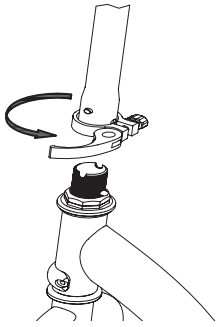

1 Open the quick release.

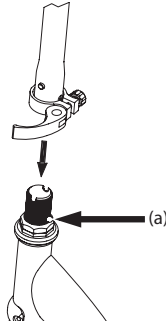

2 Depress the push button (a) located on the front fork and insert the handlebar stem until the bottom of the handlebar stem locks securely onto the fork.

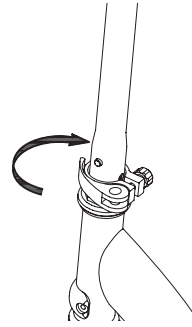

3 Adjust the tension of the quick release to where you can close the lever all the way to secure the stem.

□ Inflating the Tire

The front tire is inflated when shipped but it invariably may lose some pressure between the point of manufacturing and your purchase.

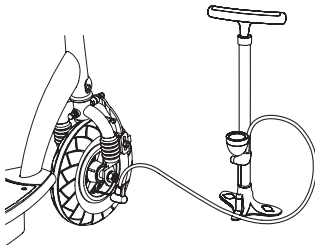

1 Using a bicycle style tire pump equipped for a Schrader-type valve, inflate the front tire to the correct PSI indicated on the sidewall of the tire.

□ Charging the Battery

Your electric scooter may not have a fully charged battery; therefore it is a good idea to charge the battery prior to use.

- Initial charge time: 12 hours
- Recharge time: up to 12 hours, depending on level of depletion and even if the light turns green.
- Fully charge battery before storing.
- When the scooter is not in regular use, recharge the battery at least once a month until normal use is resumed.
- Run time: Up to 40 minutes of continuous ride time. Run time may vary depending on riding conditions, climate and/or proper maintenance.
- Average battery life: 250 charge/discharge cycles
- To ensure long battery life, do not store the battery in temperatures above 75° or below -10° F.

Charger

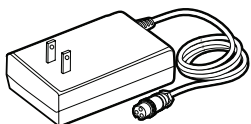

Note: Make sure power is turned **OFF** when unit is not in use. If the power switch is left on for an extended period of time, the battery may reach a stage at which it will no longer hold a charge.

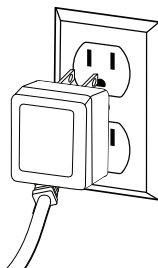

1 Plug the charger into a wall outlet. If the lights on charger do not light up, check the power to the outlet. If necessary, try a different outlet.

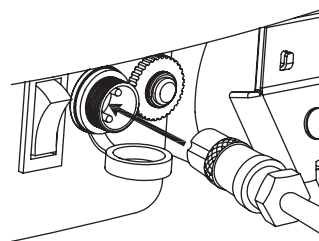

2 Turn power **OFF** before charging. Plug the charger into the charger port to charge unit.

Note: Make sure the cables/wires are out of the way before inserting the stem into the fork.

Note: The pressurized air supplies found at gasoline stations are designed to inflate high-volume automobile tires. If you decide to use such an air supply to inflate the tire, first make sure the pressure gauge is working, then use very short bursts to inflate to the correct PSI. If you inadvertently over-inflate the tire, release the excess pressure immediately.

⚠ WARNING: Failure to recharge the battery at least once a month may result in a battery that will no longer accept a charge.

⚠ WARNING: Rechargeable batteries are only to be charged under adult supervision. Always disconnect your scooter from the charger before cleaning with liquid.

Note: If your charger does not look like the one illustrated, your unit has been supplied with an alternative charger. The specifications and charging procedure would not change.

The charger has a small window with one LED to indicate the charge status. Refer to the illustration on the charger unit for the actual "charging" and "charged" status indications for your model charger.

Chargers have built-in over-charge protection to prevent battery from being over-charged.

Charger will get warm during use. This is normal for some chargers and is no cause for concern. If your charger does not get warm during use, it does not mean that it is not working properly.

ASSEMBLY AND SET-UP

□ Installing Spark Bar

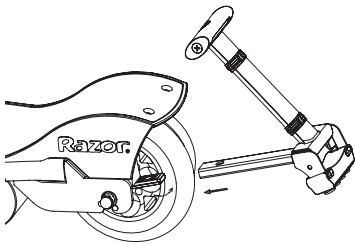

1 Using two (2) 5mm Allen wrenches remove the coupling bolt that is attached to the end of the metal bar of the Spark Bar. Slide the Spark Bar onto the metal bar located on the opposite side of the chain. Push down on the Spark Bar and slide the bar all the way on until the holes are aligned.

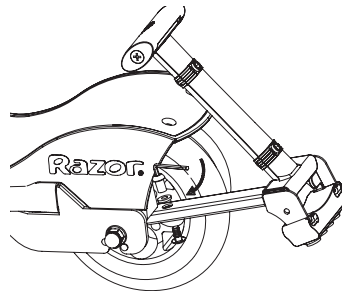

2 Re-insert the coupling bolt through the metal bar and tighten until Spark Bar is locked securely in place.

CONNECTORS/HARDWARE MAINTENANCE

□ Brake

Check the brakes for proper function. When you squeeze the lever, the brake should provide positive braking action. When you apply the brake with the speed control on, the brake cut-off switch should stop the motor. Make sure that brakes are not rubbing.

□ Frame, Fork and Handlebars

Check for cracks or broken connections. Although broken frames are rare, it is possible for an aggressive rider to run into a curb or wall and wreck and bend or break a frame. Get in the habit of inspecting your scooter on a regular basis.

□ Tires

Periodically inspect the tires for excess wear and regularly check the front tire pressure and re-inflate as necessary.

□ Safety Gear

Always wear proper protective gear such as an approved safety helmet. Elbow pads and kneepads are recommended. Always wear athletic shoes (lace-up shoes with rubber soles), never ride barefooted or in sandals, and keep shoelaces tied and out of the way of the wheels, motor and drive system.

□ Battery

Make sure the power switch is turned off whenever the scooter is not in use. Never store the product in freezing or below freezing temperatures! Freezing will permanently damage the battery. Recharge the battery at least once a month when scooter is not in use.

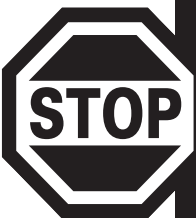

Do not use this product for the first time until you have inflated the front tire to the correct PSI and charged the battery for at least 12 hours. Failure to follow these instructions may damage your product and void your warranty.

REPAIR AND MAINTENANCE

Turn power switch "OFF" before conducting any maintenance procedures.

□ Adjusting the Brakes

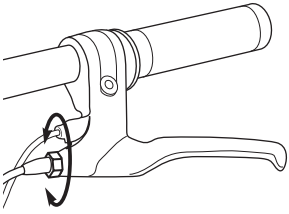

1 To adjust the brake cable play, thread the brake lever adjuster in or out 1/4 to 1/2 turn until the desired brake adjustment is attained. Most adjustments are complete at this step. If brake still needs further adjustment, proceed to step 2.

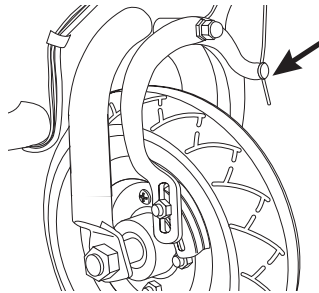

2 If brake is too tight or has too much slack, use a 10mm open wrench to loosen the brake cable and adjust accordingly.

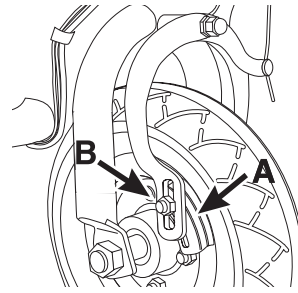

3 Inspect the brake pads (A) for proper alignment against the wheel or excess wear. To realign brake pads, loosen the fixing nut (B) and adjust the pad to contact the rim. Retighten and test. Readjust as needed.

□ Front Wheel Replacement

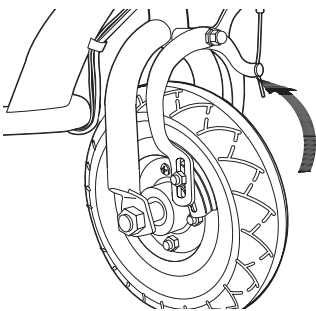

1 Using a 10mm open wrench, loosen the brake cable bolt.

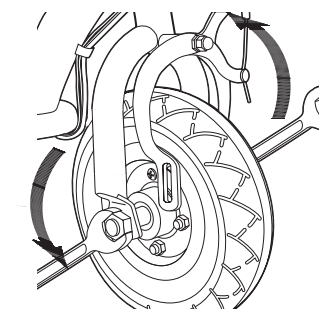

2 Using two 17mm open wrenches, loosen the locknuts by turning the wrenches counter clockwise. Remove wheel and install replacement wheel.

Note: Front wheel hardware sequence

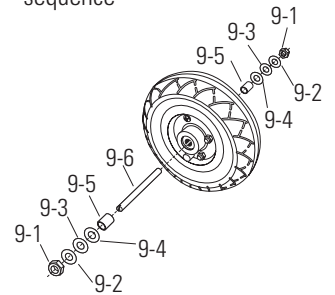

Right Side (Throttle)

9-5 - (Short) spacer

9-4 - Flat washer

Fork

9-3 - Flat washer

9-2 - Lock washer

9-1 - 17mm locknut

Middle

9-6 - Front axle bolt

Left Side (Brake)

9-5 - (Short) spacer

9-4 - Flat washer

Fork

9-3 - Flat washer

9-2 - Lock washer

9-1 - 17mm locknut

Need Help? Visit our web site for replacement parts, product support and a list of authorized service centers at www.razor.com or call toll free 866-467-2967 Monday - Friday 8AM - 5PM Pacific Time.

REPAIR AND MAINTENANCE

Chain and Rear Wheel Replacement

Tools required: Phillips screwdriver, 10mm open wrench, two (2) 8mm open wrenches, and two (2) 13mm open wrenches.

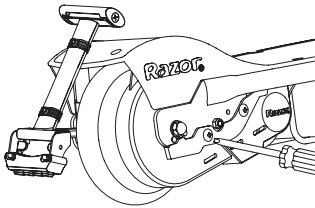

1 With a Phillips screwdriver, loosen the two screws on the chain guard and remove the chain guard.

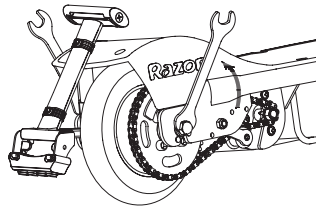

2 Using two 13mm open wrenches, loosen the locknuts by turning the wrenches counter clockwise.

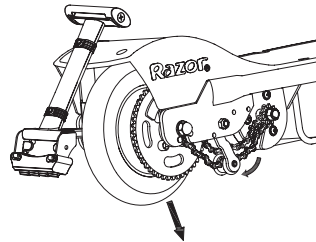

3 To loosen the chain, push the tensioner down to create some slack in the chain.

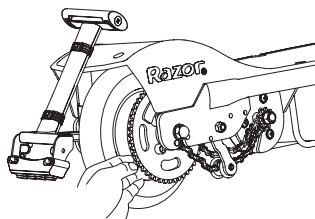

4 Remove wheel and install replacement wheel. (Note the sequence of the hardware)

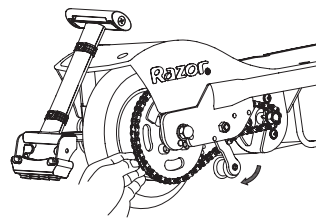

5 Push the chain tensioner down to install the chain on both sprockets.

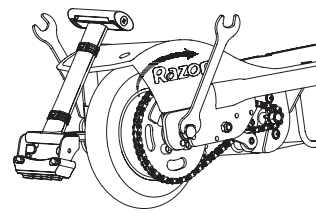

6 With two 13mm open wrenches, re-tighten the locknuts.

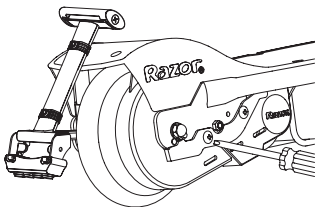

7 Re-attach the chain guard.

When to Replace the Spark Cartridge

Spark cartridge will continue to emit sparks until it is worn to the indicator line.

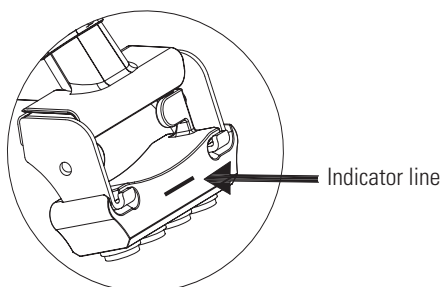

Note: Rear wheel hardware sequence

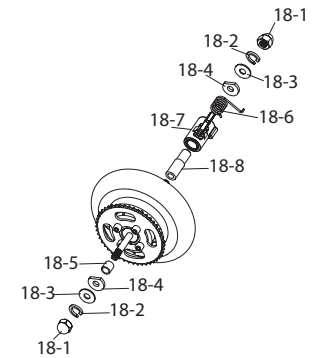

Left Side (Brake)

- 18-1 Locknut
- 18-2 Lock washer
- 18-3 Flat washer

Frame

- 18-4 Thick washer
- 18-6 Spring
- 18-7 Spring housing
- 18-8 (Long) spacer

Right Side (Throttle)

- 18-1 Locknut
- 18-2 Lock washer
- 18-3 Flat washer

Frame

- 18-4 Thick washer
- 18-5 (Short) spacer

REPAIR AND MAINTENANCE

❑ Replacing the Spark Cartridge

Friction during sparking will eventually wear out the replaceable cartridge and cause the scooter to stop making sparks. Worn out cartridges must be replaced.

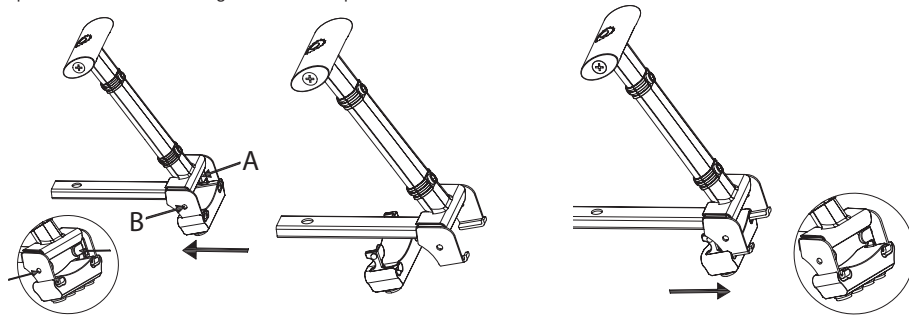

1 Using your thumbs, press tabs (A & B) on both sides of the cartridge to release from the bracket. Slide cartridge away from you and remove from bracket.

2 Place a new cartridge in back of the bracket making sure to align the slots on the cartridge with the two legs of the bracket and slide cartridge forward until you hear a click and the thumb tabs are locked in place.

❑ Using the Spark Bar

When riding, place ball of foot on the Spark Bar and gradually apply pressure. Only use enough pressure to cause sparking action. Do not engage the Spark Bar for extended or continuous periods of use.

❑ Battery Care and Disposal

Do not store the battery in temperatures above 75° F (23.8° C) or below -10° F (-23.3° C).



CONTAINS SEALED LEAD ACID BATTERIES. BATTERIES MUST BE RECYCLED.

Disposal: Your Razor product uses sealed lead-acid batteries which must be recycled or disposed of in an environmentally safe manner. Do not dispose of a lead-acid battery in a fire. The battery may explode or leak. Do not dispose of a lead-acid battery in your regular household trash. The incineration, land filling or mixing of sealed lead-acid batteries with household trash is prohibited by law in most areas. Return exhausted batteries to a federal or state approved lead-acid battery recycler or a local seller of automotive batteries. If you live in Florida or Minnesota, it is prohibited by law to throw away lead-acid batteries in the municipal waste stream.

❑ Charger

The charger supplied with the electric scooter should be regularly examined for damage to the cord, plug, enclosure and other parts and in the event of such damage, the product must not be charged until it has been repaired or replaced.

Use **ONLY** with the recommended charger.

❑ Wheels

Wheels and drive system are subject to normal wear and tear. It is the responsibility of the user to periodically inspect wheels for excess wear and adjust and replace drive train components as required.

❑ Replacement Parts

The most frequently requested replacement parts are available for purchase at some Razor retail partners. For the complete selection of replacement parts visit www.razor.com/shop.

❑ Repair Centers

For a list of authorized Razor repair centers:

- Check online at www.razor.com.
- Call 866-467-2967 for the center nearest you.

⚠ WARNING: Do not attempt to replace cartridge immediately after riding as cartridge will be hot. Handle only when cool.

⚠ WARNING: Keep fingers clear of Spark Bar hinge .

⚠ WARNING: Applying too much pressure on the Spark Bar may cause loss of control.

NOTE: Sparks and Spark cartridge life will vary based on the amount of pressure applied to the Spark Bar, the length of time pressure is applied and the smoothness of the riding surface.

⚠ WARNING: If a battery leak develops, avoid contact with the leaking acid and place the damaged battery in a plastic bag. Refer to the disposal instructions at left. If acid comes into contact with skin or eyes, flush with cool water for at least 15 minutes and contact a physician.

⚠ WARNING: Battery posts, terminals and related accessories contain lead and lead compounds. **Wash your hands after handling.**

Need Help? Visit our web site for replacement parts, product support and a list of authorized service centers at www.razor.com or call toll free 866-467-2967 Monday - Friday 8AM - 5PM Pacific Time.

TROUBLESHOOTING GUIDE

Problem	Possible Cause	Solution
Scooter does not run	Scooter must be traveling 3mph before motor will engage.	Kick start to 3mph while twisting the throttle to engage motor.
	Battery needs a charge	Charge the battery. A new battery should be charged for at least 12 hours before using the scooter for the first time and up to 12 hours after each subsequent use. Check all connectors. Make sure the charger connector is tightly plugged into the charging port and that the charger is plugged into the wall.
	Charger is not working	Make sure power flow to the wall outlet is on.
Scooter suddenly stopped working while in use	Tripped circuit breaker	Check all wires and connectors to make sure they are tight. The circuit breaker (next to on/off switch) will automatically shut off the power if the motor is overloaded. An excessive overload, such as too heavy a rider or too steep a hill, could cause the motor to overheat. If the scooter suddenly stops running, wait a few seconds and then push the breaker to reset the circuit. Correct the conditions that caused the breaker to trip to avoid repeatedly tripping the breaker.
Short run time (less than 15 minutes per charge)	Undercharged battery	Charge the battery. A new battery should be charged for at least 12 hours before using the scooter for the first time and up to 12 hours after each subsequent use. Check all wires and connectors. Make sure the battery connector is tightly plugged into the charger connector and that the charger is plugged into the wall. Make sure power flow to the wall outlet is on.
	Battery is old and will not accept full charge	Even with proper care, a rechargeable battery does not last forever. Average battery life is 1 to 2 years depending on scooter use and conditions. Replace only with a Razor replacement battery.
	Brakes are not adjusted properly	Refer to adjusting the brakes instructions on page 6.
Scooter runs sluggishly	Riding conditions are too stressful	Use only on solid, flat, clean and dry surfaces such as pavement or level ground.
	Tire is not properly inflated	The tire is inflated when shipped, but it invariably will lose some pressure between the point of manufacturing and your purchase. Refer to instructions on page 4 of this manual to properly inflate tire.
	Scooter is overloaded	Make sure you do not overload the scooter by allowing more than one rider at a time, exceeding the electric scooters 120 pounds (54kg) maximum weight limit, going up a hill or towing objects behind the scooter. If the scooter is overloaded, the circuit breaker may trip and shut off power to the motor. Correct the riding conditions that caused the overload, wait a few seconds, and then push the breaker to reset the circuit. Avoid repeatedly tripping the circuit breaker.
	Brake dragging	Turn off scooter and use your fingers to twist the adjuster in either direction until front wheel is centered between pads.
	Brakes are not adjusted properly	Refer to adjusting the brakes instructions on page 6.

TROUBLESHOOTING GUIDE

Problem	Possible Cause	Solution
Sometimes the scooter doesn't run, but other times it does	Loose wires or connectors	Check all wires around the motor and all connectors to make sure they are tight.
	Motor or electrical switch damage	Contact your local Razor authorized service center for diagnosis and repair.
Scooter makes loud noises or grinding sounds	Chain is too dry	Apply a lubricant such as 3 in 1™ or Tri-Flow™ to the chain.

For more helpful troubleshooting guides, visit us at www.razor.com.

PARTS

Keep your scooter running for years with genuine Razor parts. Visit our website for more information on spare part availability. (Specifications subject to change without notice.)

- | | | | |
|------|-------------------------------------|----|-----------------------------------|
| 01 | Handlebar grip (right/left) | 13 | Charger Port |
| 02 | Single speed twist grip throttle | 14 | Reset Button |
| 02-1 | Sleeve | 15 | Kickstand |
| 03 | Handlebar stem | 16 | Motor (24V / 100W) |
| 04 | Brake lever assembly | 17 | Battery (2 - 12V/4.5Ah) |
| 05 | Quick release | 18 | Rear wheel complete |
| 06 | Headset (upper/lower) | | (See pg. 7 for hardware sequence) |
| 07 | Front Fork with limiter | 19 | Chain tensioner |
| 08 | Front caliper brake with brake pads | 20 | Chain |
| 09 | Front wheel complete | 21 | Chain guard |
| | (See pg. 6 for hardware sequence) | 22 | Battery bracket |
| 10 | Battery Tray | 23 | Deck plate with grip tape |
| 11 | Control Module | 24 | Spark Bar |
| 12 | On/Off switch | 25 | Spark cartridge |

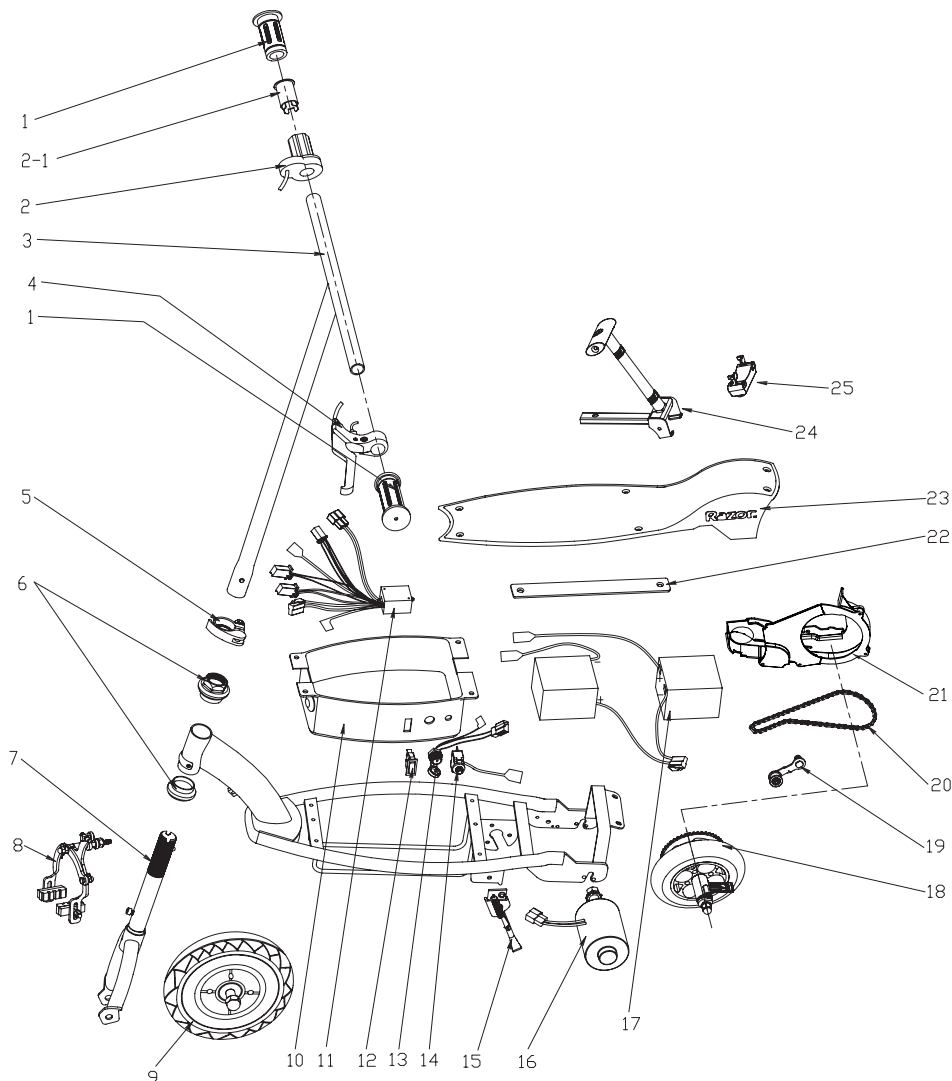

Need Help? Visit our web site for replacement parts, product support and a list of authorized service centers at www.razor.com or call toll free 866-467-2967 Monday - Friday 8AM - 5PM Pacific Time.

SB 1918 (CALIFORNIA) DECLARATION

YOUR INSURANCE POLICIES MAY NOT PROVIDE COVERAGE FOR ACCIDENTS INVOLVING THE USE OF THIS SCOOTER/ELECTRIC RIDE-ON PRODUCT. TO DETERMINE IF COVERAGE IS PROVIDED, YOU SHOULD CONTACT YOUR INSURANCE COMPANY OR AGENT.

WARRANTY

Razor Limited Warranty

The manufacturer warrants this product to be free of manufacturing defects for a period of 90 days from date of purchase. This Limited Warranty does not cover normal wear and tear, tires, tubes or cables, or any damage, failure or loss caused by improper assembly, maintenance, or storage or use of the Razor eSpark™.

This Limited Warranty will be void if the product is ever

- used in a manner other than for recreation;
- modified in any way;
- rented.

The manufacturer is not liable for incidental or consequential loss or damage due directly or indirectly to the use of this product.

Razor does not offer an extended warranty. If you have purchased an extended warranty, it must be honored by the store at which it was purchased.

For your records, save your original sales receipt with this manual and write the serial number below.

Item Number:

13111290

Need Help? Visit our web site for replacement parts, product support and a list of authorized service centers at www.razor.com or call toll free 866-467-2967 Monday - Friday 8AM - 5PM Pacific Time.

U.S. Design Patent D497,397 S

Printed in China for:
Razor USA LLC
PO Box 3610
Cerritos, CA 90703

Copyright © 2003-2011 Razor USA LLC. All rights reserved. RAZOR and the Razor Logo Design are among the registered trademarks of Razor USA LLC in the United States and/or select foreign countries. eSpark is trademark of Razor USA.

07/2011