



E300
SERIES



OWNER'S MANUAL

**Read and understand this entire manual before riding!
DO NOT RETURN TO STORE!**

**NOTE: Manual illustrations are for demonstration purposes only.
Illustrations may not reflect exact appearance of actual product.
Specifications subject to change without notice.**

**Please have your 19 digit product I.D. code ready before contacting Razor for
warranty assistance and/or replacement parts.**

Product I.D. Code: _____ - _____ - _____

CONTENTS

Safety Warnings	1	Repair and Maintenance	6-8
Before You Begin	2	Troubleshooting Guide	9
Assembly and Set-Up/Usage	3-4	Electric Scooter Parts	10
Charging Battery/Pre-Ride Checklist	5	Warranty	12

SAFETY WARNINGS

⚠ WARNING: Riding an electric scooter does present potential risks and caution is required. Like any riding product, an electric scooter has inherent hazards associated with its use (for example, falling off or riding it into a hazardous situation). Like any riding product, electric scooters can and are intended to move and it is therefore, of course, possible to lose control or otherwise get into dangerous situations. Both children and adults responsible for supervising them must recognize that if such things occur, a rider can be seriously injured or die, even when using safety equipment and other precautions. **RIDE AT YOUR OWN RISK AND USE COMMON SENSE.**

⚠ WARNING: PARENTAL AND ADULT RESPONSIBILITY AND SUPERVISION IS NECESSARY:

Because products, like electric scooters, can and do present potential hazards plainly associated with their use, it is well recognized THE NEED FOR EXERCISE OF PARENTAL RESPONSIBILITY IN SELECTING RIDING PRODUCTS APPROPRIATE TO THE AGE OF A CHILD, OR PARENTAL SUPERVISION IN SITUATIONS IN WHICH CHILDREN OF VARIOUS AGES MAY HAVE ACCESS TO THE SAME RIDING PRODUCTS, IS IMPORTANT. Not every product is appropriate for every age or size of child, and different age recommendations are found within this category of product which are intended to reflect the nature of the hazards and the expected mental or physical ability, or both, of a child to cope with the hazards.

The recommended rider age is 13 and older. Any rider unable to fit comfortably on the scooter should not attempt to ride it. A parent's decision to allow his or her child to ride this product should be based on the child's maturity, skill and ability to follow rules.

Keep this product away from small children and remember that it is intended for use only by persons who are, at a minimum, completely comfortable and competent while operating the scooter.

Persons with any mental or physical conditions that may make them susceptible to injury, impair their physical dexterity or mental capabilities to recognize, understand, and follow safety instructions and to be able to understand the hazards inherent in scooter use, should not use or be permitted to use products inappropriate for their abilities. Persons with heart conditions, head, back or neck ailments (or prior surgeries to these areas of the body), or pregnant women, should be cautioned not to operate such products.

DO NOT EXCEED THE WEIGHT LIMIT OF 220 lbs (100 kg). Rider weight does not necessarily mean a person's size is appropriate to fit or maintain control of the scooter.

CHECK AND MAINTAIN SCOOTER CONDITIONS

Before use, check to confirm that any and all chain guards or other covers and guards are in place and in serviceable condition. Check that the brake is functioning properly, and that tires are inflated properly and have sufficient tread remaining. The scooter should be maintained and repaired in accordance with the manufacturer's specifications, using only the manufacturer's authorized replacement parts, and should not be modified from the manufacturer's original design and configuration.

ACCEPTABLE RIDING PRACTICES AND CONDITIONS

Always check and obey any local laws or regulations, which may affect the locations where the electric scooter may be used. Keep safely away from cars and motor vehicle traffic at all times, and only use where allowed and with caution.

Do not activate the speed control on the hand grip unless you are on the scooter and in a safe, outdoor environment suitable for riding.

The normal powered top speed of this scooter will be approximately 15 mph (24 kmh), which can be affected by conditions, such as rider weight, inclines, tire inflation and battery charge level. Avoid excessive speeds that can be associated with downhill rides.

Maintain a hold on the handlebars at all times. Do not touch the brakes or motor on your scooter when in use or immediately after riding as these parts can become very hot.

Ride defensively. Watch out for potential obstacles that could catch your wheel or force you to swerve suddenly or lose control. Be careful to avoid pedestrians, skaters, skateboards, scooters, bikes, children or animals who may enter your path, and respect the rights and property of others.

The electric scooter is intended for use on flat, dry surfaces such as pavement or level ground, without loose debris, such as sand, leaves, rocks or gravel. Wet, slick, bumpy, uneven or rough surfaces may impair traction and contribute to possible accidents. Do not ride your scooter in mud, ice, puddles or water. Watch out for potential obstacles that could catch your wheel or force you to swerve suddenly or lose control. Avoid sharp bumps, drainage grates, and sudden surface changes.

Do not attempt or do stunts or tricks on your electric scooter. The scooter is not made to withstand abuse from misuse, such as jumping, curb grinding or any other type of stunts. Racing, stunt riding, or other maneuvers also enhance risk of loss of control, or may cause uncontrolled rider actions or reactions.

Never allow more than one person at a time to ride the scooter.

Do not ride at night or when visibility is limited.

Never use near steps or swimming pools.

Do not allow hands, feet, hair, body parts, clothing, or similar articles to come in contact with moving parts, wheels, or drivetrain, chain while the motor is running.

Never use headphones or a cell phone to talk or text when riding.

Never hitch a ride with a vehicle.

Do not ride your scooter in wet or icy weather and never immerse the scooter in water, as the electrical and drive components could be damaged by water or create other possibly unsafe conditions. Never risk damaging surfaces, such as carpet or flooring, by use of an electric scooter indoors.

PROPER RIDING ATTIRE

Always wear proper protective equipment, such as an approved safety helmet (with chin strap securely buckled), elbow pads and kneepads. A helmet may be legally required by local law or regulation in your area. A long-sleeved shirt, long pants, and gloves are recommended. Always wear athletic shoes (lace-up shoes with rubber soles), never ride barefooted or in sandals, and keep shoelaces tied and out of the way of the wheels, motor and drive system.

USING THE CHARGER

The charger supplied with the electric scooter should be regularly examined for damage to the cord, plug, enclosure and other parts. In the event of such damage, the scooter must not be charged until the charger has been repaired or replaced.

Use only with the recommended charger.

Use caution when charging.

The charger is not a toy. Charger should be operated by an adult.

Do not operate charger near flammable materials.

Unplug charger and disconnect from scooter when not in use.

Do not exceed charging time.

Always disconnect from the charger prior to wiping down and cleaning your scooter with damp cloth.

FAILURE TO USE COMMON SENSE AND HEED THE ABOVE WARNINGS INCREASES RISK OF SERIOUS INJURY. USE WITH APPROPRIATE CAUTION AND SERIOUS ATTENTION TO SAFE OPERATION.

BEFORE YOU BEGIN

Remove contents from box. Remove the foam separators that protect the components from damage during shipping. Inspect the contents of the box for scratches in the paint, dents or kinked cables that may have occurred during shipping. Because the scooter is 95 percent assembled and packed at the factory, there should not be any problems, even if the box has a few scars or dents.

MAKE SURE POWER SWITCH IS TURNED "OFF" BEFORE CONDUCTING ANY ASSEMBLY OR MAINTENANCE PROCEDURES.

Estimated Assembly and Set-Up Time

Allow up to 10 minutes for assembly, not including initial charge time.

Allow up to 12 hours for initial charge (see page 5 for charging information)

3. Charger

(Note: Charger design may vary from one shown)

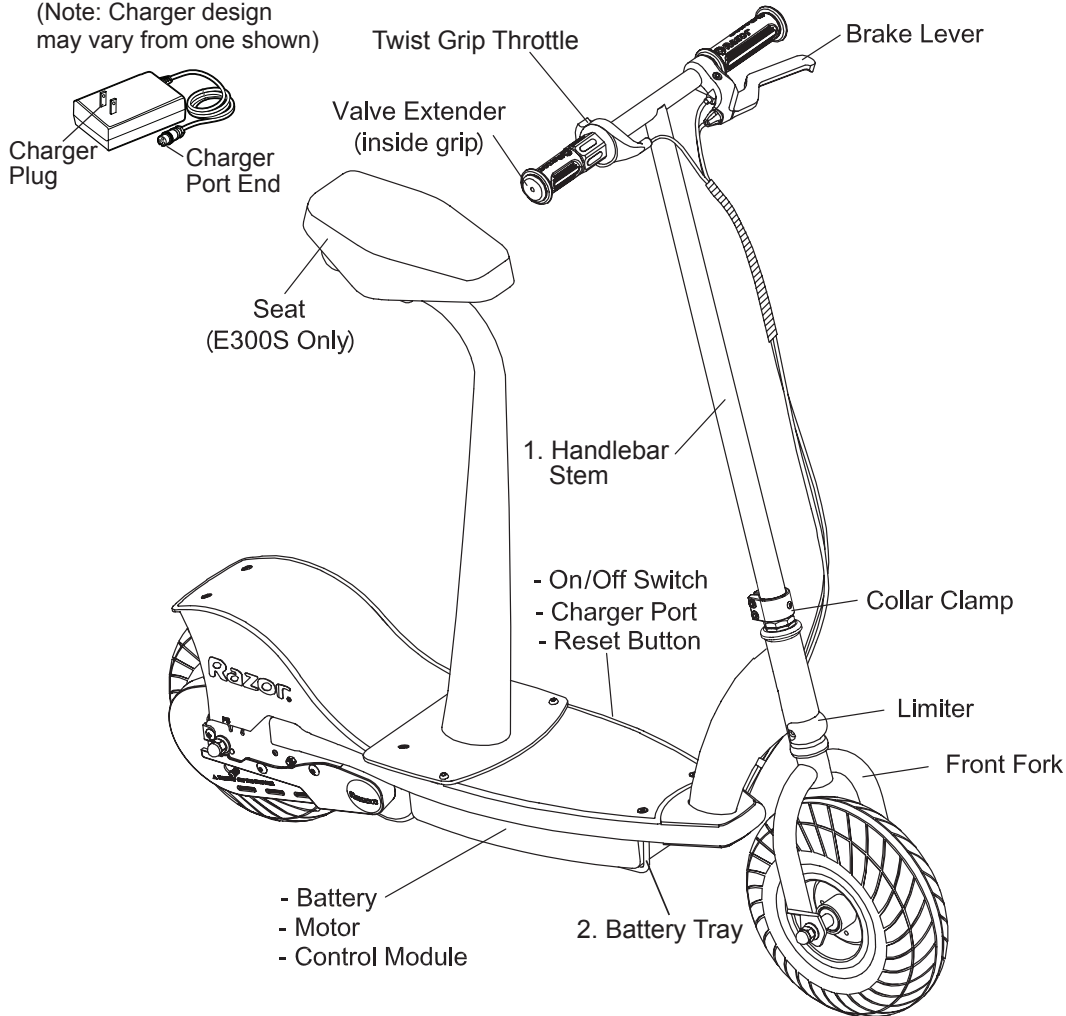

WARNING: DO NOT USE NON-RAZOR PARTS WITH YOUR RAZOR ELECTRIC SCOOTER. The scooter has been built to certain Razor design specifications. The original equipment supplied at the time of sale was selected on the basis of its compatibility with the frame, fork and all other parts. Certain aftermarket parts may or may not be compatible and will void your warranty.

PRODUCT I.D. CODE

1. Handlebar Stem
2. Battery Tray
3. Charger
4. UPC Side of Box (not shown)

Required Tools

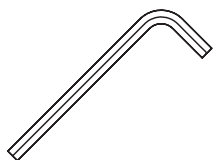

5 mm Allen Wrench (Included)
Two (2) 4 mm Allen Wrenches
(Only Included with E300S)

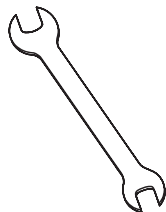

8 mm/10 mm/16 mm
Wrenches (Not Included)

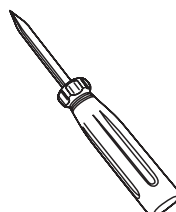

Phillips Screwdriver
(Only Included with E300S)

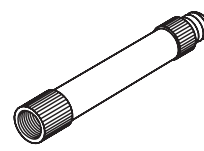

Valve Extender
(Located in right handlebar grip)

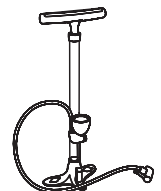

Bicycle-style tire pump
for Schrader valve tires
with pressure gauge
(Not Included)

Need Help? Visit our website for replacement parts, product support and a list of authorized service centers at www.razor.com or call toll free 866-467-2967 Monday - Friday 8AM - 5PM Pacific Time. Please have the product I.D. code (located on the white label on your product or back of charger) available for better assistance.

ASSEMBLY AND SET-UP

□ Attaching the Handlebars

Tools required: 5 mm Allen wrench.

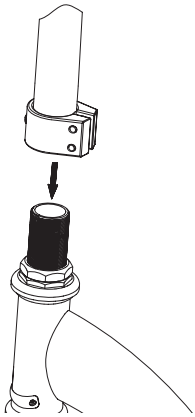

1 Loosen the collar clamp and slide it upward. With a twisting motion, push and twist to slide the steering tube onto the fork.

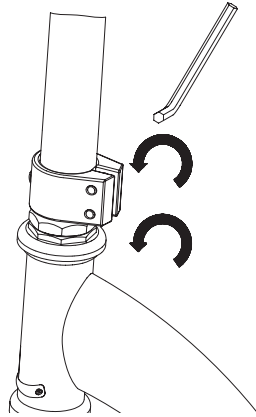

2 With the front wheel pointed straight ahead and the handlebars square to the front wheel, tighten the clamp as shown. Tighten securely.

□ Inflating the Tires

Tires are inflated when shipped, but they invariably lose some pressure between the point of manufacturing and your purchase. **Always inflate tires to the correct PSI before first time use.**

Rear Tire

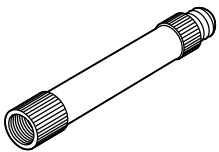

1 Use the valve extender located inside the end of the right handlebar grip.

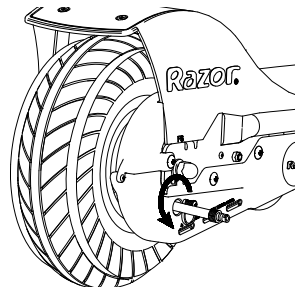

2 Open the round cover located on the chain cover by sliding the cover upward. Align the opening in the drive sprocket with the valve stem. Thread the valve extender completely onto the valve stem and attach the pump. Inflate to the PSI indicated on the tire sidewall.

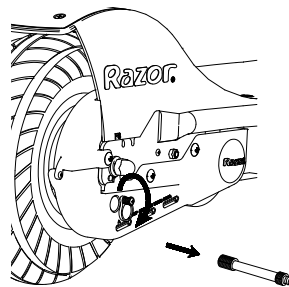

3 Remove valve extender immediately after inflating and close the round cover.

Front Tire

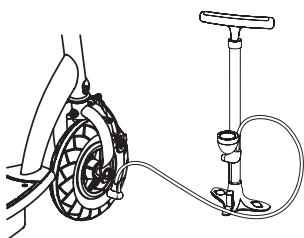

4 Using a bicycle tire pump equipped for a Schrader valve, inflate the front tire to the PSI indicated on the sidewall of the tire.

Note: Make sure the cables/wires are out of the way before inserting the stem in the fork.

⚠ WARNING: Failure to properly tighten the collar clamp may allow the handlebars to dislodge while riding and may cause you to lose control and fall. When correctly tightened, the handlebars will not rotate out of alignment with the front wheel under normal circumstances.

Note: The cable and wire assembly from the handlebar must not wrap around the steering tube or handlebar. Sharp bends or twisting of the brake cable can cause the brakes to malfunction.

⚠ WARNING: Failure to remove the valve extender after inflating will cause the inner tube and/or adapter to be severed by the rear drive sprocket.

Note: If you lose the valve extender, contact customer service or one can be purchased at almost any auto parts store.

⚠ WARNING: Do not over inflate, as this could damage tire or wheel

Note: The pressurized air supplies found at gasoline stations are designed to inflate high-volume automobile tires. If you decide to use such an air supply to inflate your electric scooter tires, first make sure the pressure gauge is working, then use very short bursts to inflate to the correct PSI. If you inadvertently over-inflate the tire, release the excess pressure immediately.

ASSEMBLY AND SET-UP

□ Attaching the Seat (E300S Only)

Tools required: Two (2) 4 mm Allen wrenches and Phillips screwdriver.

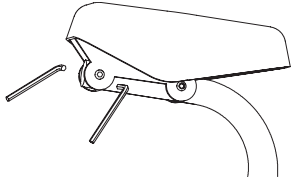

1 Attach the seat to the seat post with two (2) 4 mm Allen wrenches. See note below.

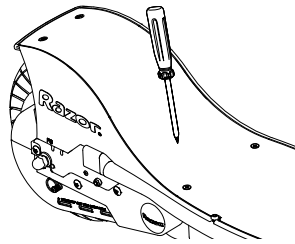

2 Remove the four screws on the middle of the deck with the 4 mm Allen wrench and the Phillips screwdriver.

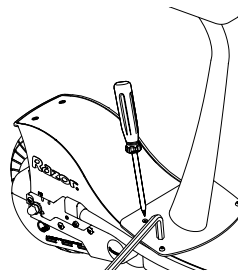

3 Place the seat post on the deck and secure using the same 4 screws.

Note: Do not completely tighten at this time. Adjust the seat tilt approximately level to the ground, or slightly tilted depending on your personal preference. Tighten securely. The seat tilt adjustment should not move when riding.

USAGE

□ Starting the Scooter

To start unit, turn on power switch and twist throttle with both hands on the handlebar.

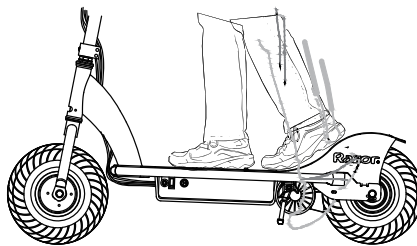
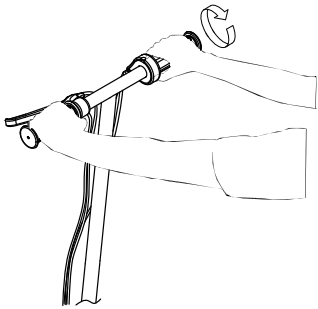

□ Stopping the Scooter

To stop unit, release the throttle and apply the brake until the unit comes to a complete stop.

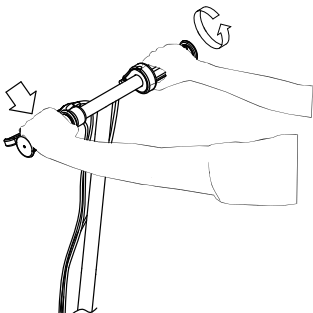

Note: As an additional safety feature, the scooter is designed to cut power to the motor when the hand brake is applied.

Need Help? Visit our website for replacement parts, product support and a list of authorized service centers at www.razor.com or call toll free 866-467-2967 Monday - Friday 8AM - 5PM Pacific Time. Please have the product I.D. code (located on the white label on your product or back of charger) available for better assistance.

CHARGING BATTERY

□ Charging the Battery

Charge the battery prior to use.

- Initial charge time: 12 hours
- Recharge time: up to 12 hours, even if the light turns green. Recommended maximum charging time is 24 hours.
- Always charge the battery immediately after riding.
- Fully charge battery before storing for extended periods of time.
- Unplug charger from the wall outlet when not in use.
- Failure to recharge battery periodically may result in a battery that will not accept a charge.
- Make sure scooter power switch is turned **OFF** when unit is not in use. If the power switch is left on for an extended period of time, the battery may reach a stage at which it will no longer hold a charge.
- To ensure long battery life, never store the product in freezing or below freezing temperatures! Freezing will permanently damage the battery.
- Run time: Up to 40 minutes of continuous ride time. Run time may vary depending on riding conditions, climate and/or proper maintenance.
- Constant stopping and starting may shorten ride time.
- Average battery life for a properly maintained unit is approx. 250 charge/discharge cycles.

Charger

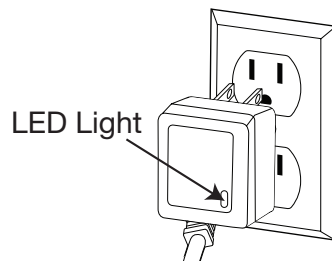
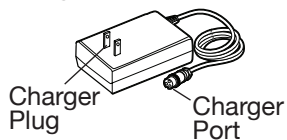

1 Plug the charger into a wall outlet. If the lights on charger do not light up, check the power to the outlet. If necessary, try a different outlet.

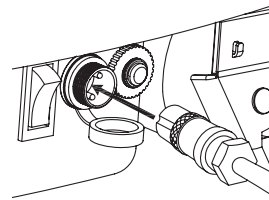

2 Turn scooter power switch **OFF** before charging. Plug the charger into the charger port on the electric scooter.

⚠ **WARNING:**

Rechargeable batteries are only to be charged under adult supervision. Always disconnect your scooter from the charger before cleaning with damp cloth.

Note: If your charger does not look like the one illustrated, your unit has been supplied with an alternative charger. The specifications and charging procedure would not change.

The charger has a small window with one LED light to indicate the charge status. Refer to the illustration on the charger unit for the actual "charging" and "charged" status indications for your model charger.

Chargers have built-in over-charge protection to prevent battery from being over-charged.

Charger may get warm during use. This is normal for some chargers and is no cause for concern. If your charger does not get warm during use, it does not mean that it is not working properly.

⚠ **WARNING:** Battery charge can deplete over time. Periodically recharge battery when not in use.

PRE-RIDE CHECKLIST



Brake

Check the brakes for proper function. When you squeeze the lever, the brake should provide positive braking action. Make sure that brakes are not rubbing.



Frame, Fork and Handlebars

Check for cracks or broken connections. Although broken frames are rare, it is possible for an aggressive rider to run into a curb or wall and wreck, bend or break a frame. Get into the habit of inspecting your scooter on a regular basis.



Tires

Periodically inspect the tires for excess wear and regularly check the tire pressure. Re-inflate as necessary.



Hardware

Check all parts such as nuts, bolts, cables, fasteners, etc. to ensure they are secure and assembled correctly. If the unit is damaged do not ride. Reference "Safety Warnings" on page 1 of this manual.



Laws and Regulations

Always check and obey any local laws or regulations.



Insurance

Do not assume that your existing insurance policies necessarily provide coverage for scooter use. Check with your insurance company for information regarding insurance.

REPAIR AND MAINTENANCE

Turn power switch "OFF" before beginning repair or maintenance:

- Read the instructions
- Remove Charger Plug
- Turn the power switch off
- Secure the unit under repair
- Exercise caution around exposed parts
- Contact Razor customer service if unsure about any repair or maintenance

□ Adjusting the Brakes

Tools required: 10 mm wrench

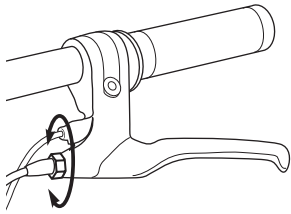

1 To adjust the brake cable tension, thread the brake lever adjuster in or out 1/4 to 1/2 turn until the desired brake adjustment is attained. Most adjustments are complete at this step. If brake still needs further adjustment, proceed to step 2.

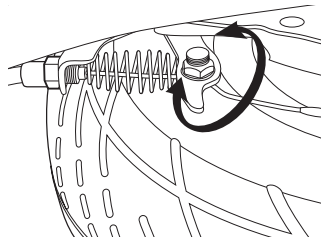

2 If the brake is too tight or too loose, use a 10 mm open wrench to loosen the nut for additional adjustment on the brake cable. Securely tighten the nut when finished.

□ Chain and Rear Tire Replacement

Tools required: Phillips screwdriver, 10 mm wrench, two (2) 8 mm wrenches, and two (2) 16 mm wrenches.

Disassembly

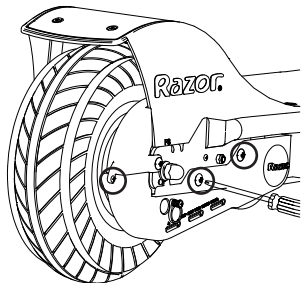

1 With a Phillips screwdriver, loosen the 3 screws and remove the chain guard.

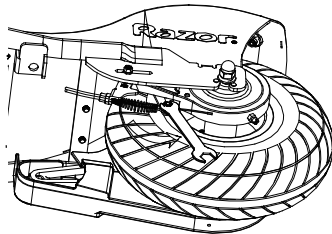

2 With a 10 mm wrench, loosen the brake cable anchor bolt and disconnect the cable.

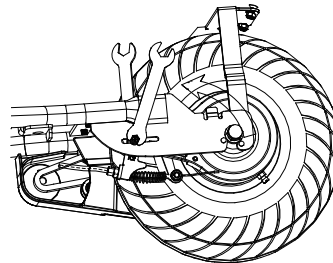

3 With two (2) 8 mm wrenches, remove the cable guide bracket from the frame and brake plate. Keep the bolt, washers, and nuts together.

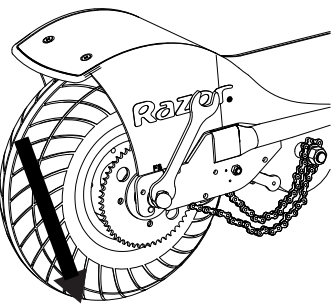

4 With two (2) 16 mm wrenches, loosen the axle locknuts. Push down and remove wheel from the frame. Remove chain from rear sprocket.

⚠ WARNING:

The brake is capable of skidding the rear tire and throwing an unsuspecting rider. Practice in an open area free from obstacles until you are familiar with the brake function. Avoid skidding to a stop as this can cause you to lose control and/or damage the rear tire.

Note: Rear wheel hardware sequence.

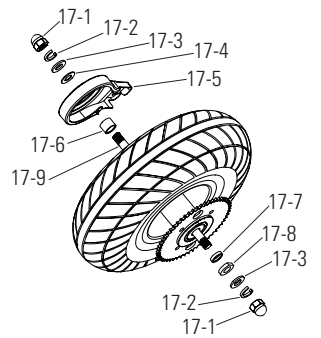

Left Side (Brake)

- 17-1 Locknut
- 17-2 Spring Washer
- 17-3 Washer (thick)

Frame

- 17-4 Washer (thin)
- 17-5 Brake Plate
- 17-6 Spacer

Middle

- 17-9 Rear Axle Bolt

Right Side (Throttle)

- 17-7 Spacer
- 17-8 Washer (plate cut)

Frame

- 17-3 Washer (thick)
- 17-2 Spring Washer
- 17-1 Locknut

Need Help? Visit our website for replacement parts, product support and a list of authorized service centers at www.razor.com or call toll free 866-467-2967 Monday - Friday 8AM - 5PM Pacific Time. Please have the product I.D. code (located on the white label on your product or back of charger) available for better assistance.

REPAIR AND MAINTENANCE

Reassembly

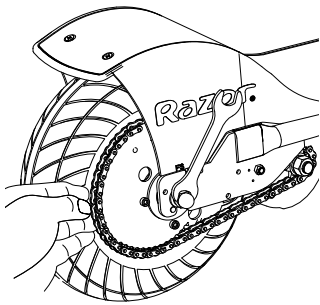

5 Install the chain onto the rear wheel sprocket. Slip wheel axle into the frame slots. See rear wheel hardware sequence on prior page. Push the chain tensioner down to create slack in chain. Hand tighten rear axle locknuts.

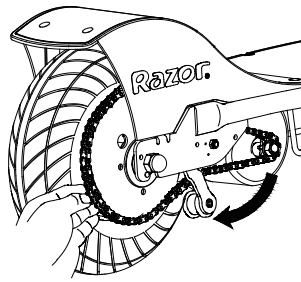

6 Verify chain is properly installed on each sprocket and tensioner is correctly positioned at the bottom of the chain.

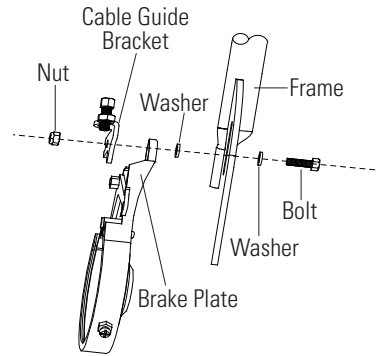

7 Install the cable guide bracket to the frame and brake plate using bolt, washers, and nut. Do not tighten.

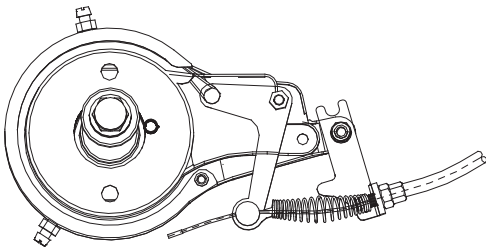

8 Thread the brake cable through the brake adjuster barrel, through the large spring, and into the small hole in the side of the anchor bolt. Position the cable to the original location (as indicated by the slight cable kink) and tighten securely.

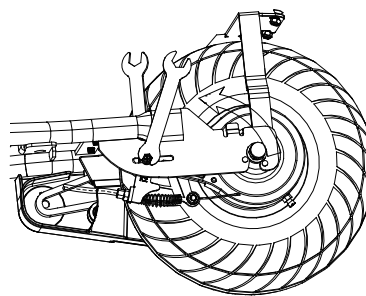

9 Tighten the cable guide bracket bolt. Tighten the locknuts on the rear axle. Test the brake to verify proper function before riding. Readjust as needed

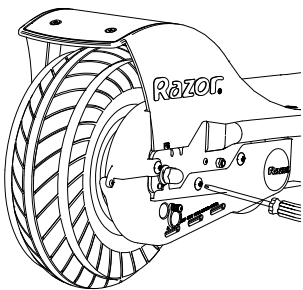

10 Replace the chain guard.

Turn power switch "OFF" before conducting any maintenance procedures.

□ Front Tire Replacement

Tools required: Two (2) 16 mm wrenches.

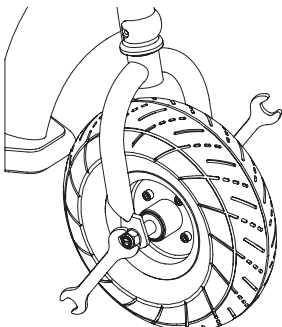

1 Using two (2) 16 mm wrenches, loosen the front axle bolts by turning the wrenches counter clockwise. Remove wheel and install replacement wheel. Note the sequence of hardware.

Note: Front wheel hardware sequence.

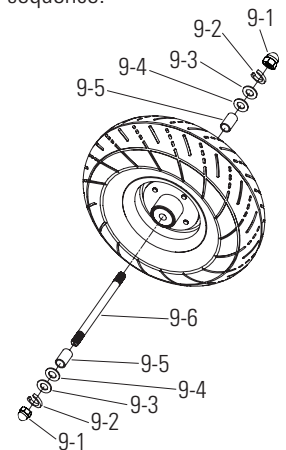

Right Side (Throttle)

9-5 - Spacer

9-4 - Washer

Fork

9-3 - Washer

9-2 - Spring Washer

9-1 - 16 mm Locknut

Middle

9-6 - Front Axle Bolt

Left Side (Brake)

9-5 - Spacer

9-4 - Washer

Fork

9-3 - Washer

9-2 - Spring Washer

9-1 - 16 mm Locknut

REPAIR AND MAINTENANCE

❑ Battery Care and Disposal

Do not store in freezing or below freezing temperatures. To properly maintain your battery and ensure maximum battery life, carefully read the "Charging the Battery" section on page 5 of this owner's manual.



CONTAINS SEALED LEAD ACID BATTERIES. BATTERIES MUST BE RECYCLED.

Disposal: Your Razor product uses sealed lead-acid batteries which must be recycled or disposed of in an environmentally safe manner. Do not dispose of a lead-acid battery in a fire. The battery may explode or leak. Do not dispose of a lead-acid battery in your regular household trash. The incineration, land filling or mixing of sealed lead-acid batteries with household trash is prohibited by law in most areas. Return exhausted batteries to a federal or state approved lead-acid battery recycler or a local seller of automotive batteries. If you live in Florida or Minnesota, it is prohibited by law to throw away lead-acid batteries in the municipal waste stream.

❑ Charger

The charger supplied with the electric scooter should be regularly examined for damage to the cord, plug, enclosure and other parts and in the event of such damage, the product must not be charged until it has been repaired or replaced.

Use **ONLY** the charger supplied with this product or a recommended replacement specified by Razor.

❑ Wheels

Wheels and drive system are subject to normal wear and tear. It is the responsibility of the user to periodically inspect wheels for excess wear and adjust and replace drive train components as required.

❑ Replacement Parts

For the complete selection of replacement parts visit www.razor.com.

❑ Repair Centers

For a list of authorized Razor repair centers:

- Check online at www.razor.com.
- Call 866-467-2967 for the center nearest you.

! WARNING: If a battery leak develops, avoid any contact with leaking acid and place the damaged battery in a plastic bag. Refer to the disposal instructions at left. If acid comes into contact with skin or eyes, flush with cool water for at least 15 minutes and contact a physician.

! WARNING: Battery posts, terminals and related accessories contain lead and lead compounds. **Wash your hands after handling.**

Need Help? Visit our website for replacement parts, product support and a list of authorized service centers at www.razor.com or call toll free 866-467-2967 Monday - Friday 8AM - 5PM Pacific Time. Please have the product I.D. code (located on the white label on your product or back of charger) available for better assistance.

*Unit(s) should be turned off and fully charged prior to doing any Troubleshooting

NOTE: All troubleshooting steps should be performed by an adult only

TROUBLESHOOTING GUIDE

Problem	Possible Cause	Solution
Does Not Work Out Of The Box	Loose connection(s)	Check for loose connections/wires
No Longer Works	Loose connection(s)	Check for loose connections/wires
	Charger not working	Check power to wall outlet and/or try a different outlet Check lights on charger: Plugged into wall = Green Plugged into wall & unit = Red = Charging Charging Complete = Green No lights - Replace Charger
	Tripped reset button	Secure unit; turn the power switch on and with no weight on the unit, lift up back end and apply the throttle. If motor engages - Replace Battery The reset button will trip if the motor is overloaded. An excessive overload may be caused, for example, by too heavy a rider, too steep a hill, etc. Wait a few seconds then press reset button. Correct riding conditions to prevent overload
	Battery will not hold a charge	If motor does not engage, but makes a clicking sound - Replace battery if motor does not engage, no clicking sound - Replace Control Module
Short Ride Time/Runs Slow	Rider weight	Do not exceed 220 lbs maximum weight limit
	Low tire pressure	Tires will lose pressure over time. Verify correct air pressure
	Riding conditions	Use only on flat, dry surfaces. Avoid inclines and areas with heavy debris
	Battery not fully charged	Charge unit for a full 12 hrs
	Old/damaged battery	Secure unit; turn the power switch on and with no weight on the unit, lift up back end and apply the throttle. If motor engages - Replace Battery Charge battery periodically when not in use
	Improper battery maintenance	Do not store unit in freezing or below freezing temperatures. Freezing will permanently damage the battery and greatly reduce ride time. Refer to Page 5 Charging the Battery
	Brake is dragging	Check the brake cable has 2-3 mm of slack at lever. Cables should NOT be wrapped around the handlebar stem. Adjust brake cable slack according to page 6 instructions
Runs Intermittently	Loose connection(s)	Check the wires around the throttle and for other possible loose connections Replace - throttle

Need Help? Visit our website for replacement parts, product support and a list of authorized service centers at www.razor.com or call toll free 866-467-2967 Monday - Friday 8AM - 5PM Pacific Time. Please have the product I.D. code (located on the white label on your product or back of charger) available for better assistance.

E300 / E300S SCOOTER PARTS

Keep your scooter running for years with genuine Razor parts. Visit our website or e-mail us for more information on spare part availability. (Specifications subject to change without notice.)

- | | | |
|------------------------------------|--|--|
| 1 Handlebar Grip (right/left) | 8 Front Fork | 17 Rear Wheel Complete
(See page 6 for hardware sequence) |
| 1-1 Handlebar End Cap | 9 Front Wheel Complete
(See page 7 for hardware sequence) | 18 Chain Tensioner |
| 1-2 Valve Extender | 10 Control Module | 19 Chain |
| 2 Single Speed Twist Grip Throttle | 11 Battery Tray | 20 Chain Guard |
| 2-1 Sleeve | 12 Reset Button | 21 Battery (2x 12V/7Ah) |
| 3 Handlebar Stem | 13 On/ Off Switch | 22 Battery Bracket |
| 4 Brake Lever Assembly | 14 Charger Port | 23 Deck Plate with Grip Tape |
| 5 Collar Clamp | 15 Motor (24V/250W) | 24 Seat Post with Seat (E300S only) |
| 6 Headset (upper/lower) | 16 Kickstand | |
| 7 Limiter and Cover | | |

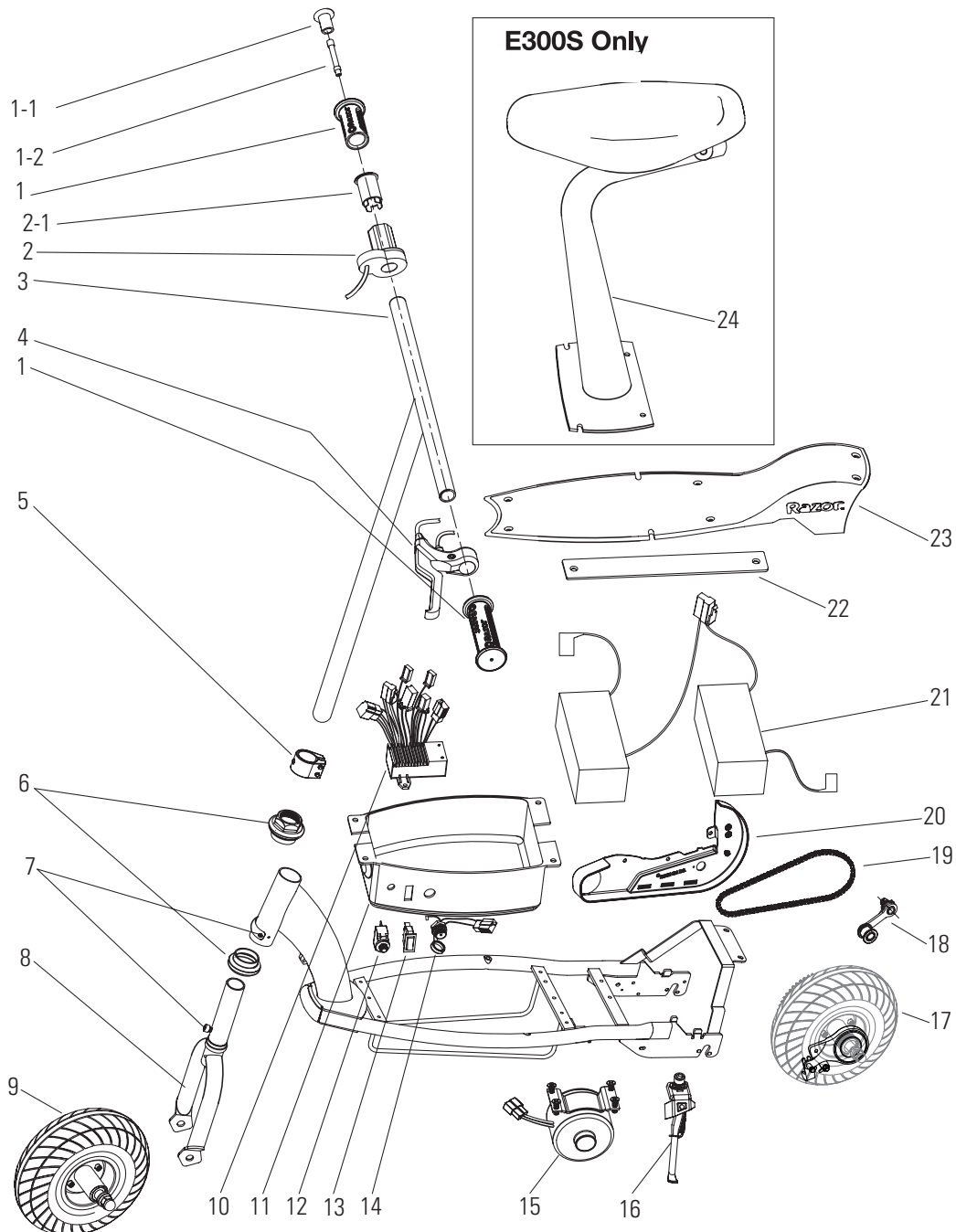

SB 1918 (CALIFORNIA) DECLARATION

YOUR INSURANCE POLICIES MAY NOT PROVIDE COVERAGE FOR ACCIDENTS INVOLVING THE USE OF THIS SCOOTER/ELECTRIC RIDE-ON PRODUCT. TO DETERMINE IF COVERAGE IS PROVIDED, YOU SHOULD CONTACT YOUR INSURANCE COMPANY OR AGENT.

WARRANTY

Razor Limited Warranty

The manufacturer warrants this product to be free of manufacturing defects for a period of 90 days from date of purchase. This Limited Warranty does not cover normal wear and tear, tires, tubes or cables, or any damage, failure or loss caused by improper assembly, maintenance, or storage or use of the Razor electric scooter.

This Limited Warranty will be void if the product is ever:

- used in a manner other than for recreation or transportation;
- modified in any way;
- rented.

The manufacturer is not liable for incidental or consequential loss or damage due directly or indirectly to the use of this product.

Razor does not offer an extended warranty. If you have purchased an extended warranty, it must be honored by the store at which it was purchased.

For your records, save your original sales receipt with this manual and write the serial number below.

Community Design No. 130919-0001
U.S. Design Patent D497,397 S
U.S. Design Patent D513,629 S
Canadian Design Registration No. 105673

Printed in China for:
Razor USA LLC
PO Box 3610
Cerritos, CA 90703

Copyright © 2003-2012 Razor USA LLC. All rights reserved. RAZOR and the Razor Logo Design are among the registered trademarks of Razor USA LLC in the United States and/or select foreign countries.